



安裝手冊

Stage2 624

Stage2 9634

Stage2 634

Stage2 604C





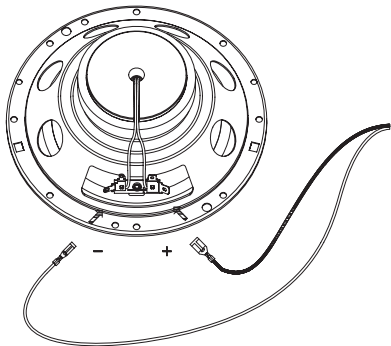
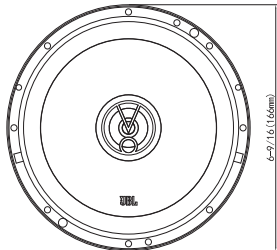
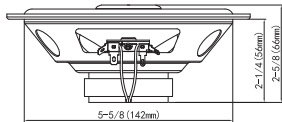

Stage2 424

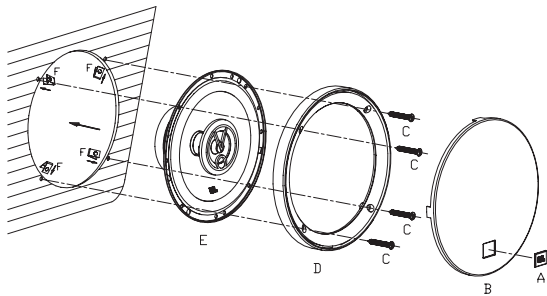
Stage2 524

Stage2 624





<p>A</p>  <p>2x</p>	<p>B</p>  <p>2x</p>	<p>C</p>  <p>8x</p>	<p>D</p>  <p>2x</p>	<p>E</p>  <p>2x</p>	<p>F</p>  <p>8x</p>
--	--	--	--	--	--

規格

- 類型：6-1/2” (160mm) 雙向同軸汽車喇叭
- 功率容量：40Wrms, 240W 峰值
- 靈敏度 (2.83 伏特) :91dB
- 頻率響應：55Hz – 20kHz
- 額定阻抗：4 ohms



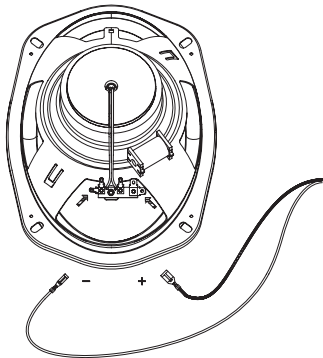
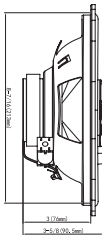
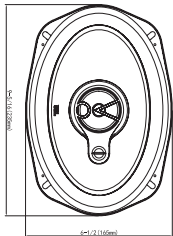
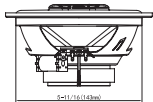

Thiele-Small 參數

- BL (Tm): 3.241
- DCR (ohm): 3.2
- Mms (g): 8.031
- Sd (cm²): 128.68
- Cms (μm/N): 427.874
- Vas (l): 10.061
- Fs (Hz): 85
- Qes: 1.32
- Qms: 4.242
- Qts: 1.007
- Crossover Point: 4.6 kHz

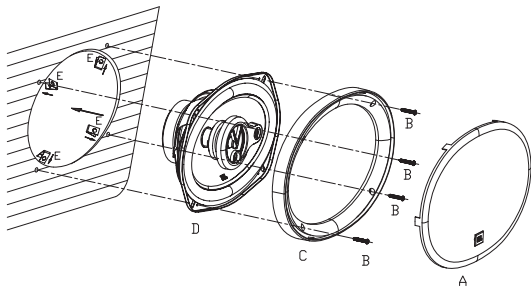
Stage2 9634





<p>A</p>  <p>2x</p>	<p>B</p>  <p>8x</p>	<p>C</p>  <p>2x</p>	<p>D</p>  <p>2x</p>	<p>E</p>  <p>8x</p>
--	--	--	---	--

規格

- 類型: 6" x 9" (152mm x 230mm) 三向汽車喇叭
- 功率容量: 70Wrms, 420W 峰值
- 靈敏度 (2.83 伏特) : 92dB
- 頻率響應: 50Hz – 21kHz
- 額定阻抗: 4 ohms





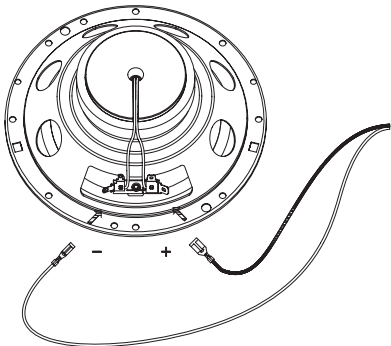
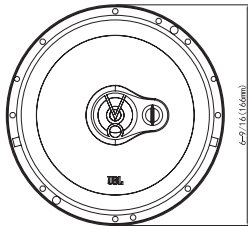
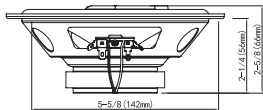

Thiele-Small 參數

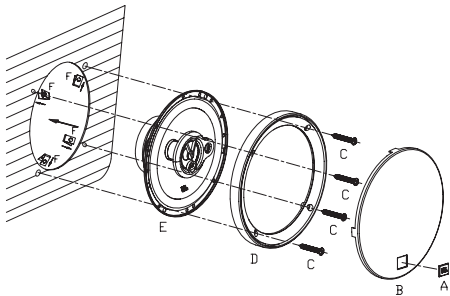
- BL (Tm): 3.496
- DCR (ohm): 2.3
- Mms (g): 17.755
- Sd (cm²): 213.565
- Cms (μm/N): 306.333
- Vas (l): 19.84
- Fs (Hz): 70
- Qes: 1.432
- Qms: 3.99
- Qts: 1.054
- Crossover Point: 3.6 kHz

Stage2 634





<p>A</p>  <p>2x</p>	<p>B</p>  <p>2x</p>	<p>C</p>  <p>8x</p>	<p>D</p>  <p>2x</p>	<p>E</p>  <p>2x</p>	<p>F</p>  <p>8x</p>
--	--	--	--	--	--

規格

- 類型:6-1/2” (160mm) 三向汽車喇叭
- 功率容量:40Wrms, 250W 峰值
- 靈敏度 (2.83 伏特) :91dB
- 頻率響應:55Hz – 20kHz
- 額定阻抗:4 ohms







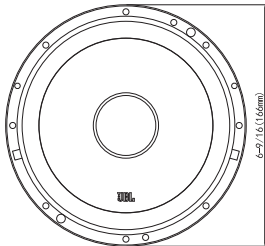
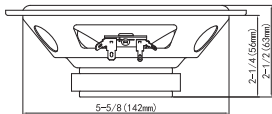

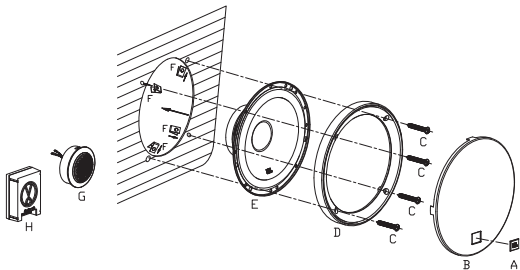
Thiele-Small 參數

- BL (Tm): 3.241
- DCR (ohm): 3.2
- Mms (g): 8.031
- Sd (cm²): 128.68
- Cms (μm/N): 427.874
- Vas (l): 10.061
- Fs (Hz): 85
- Qes: 1.32
- Qms: 4.242
- Qts: 1.007
- Crossover Point: 4.2 kHz

Stage2 604C





<p>A</p>  <p>2x</p>	<p>B</p>  <p>2x</p>	<p>C</p>  <p>8x</p>	<p>D</p>  <p>2x</p>	<p>E</p>  <p>2x</p>	<p>F</p>  <p>4x</p>	<p>G</p>  <p>2x</p>	<p>H</p>  <p>2x</p>
--	--	--	--	--	--	--	--

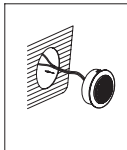

規格

- 類型: 6-1/2" (160mm) 雙向元件喇叭系統
- 功率容量: 45Wrms, 270W 峰值
- 靈敏度 (2.83 伏特): 91dB
- 頻率響應: 55Hz – 20kHz
- 阻抗: 4 ohms



Thiele-Small 參數

- BL (Tm): 3.588
- DCR (ohm): 3.2
- Mms (g): 11.01
- Sd (cm²): 128.68
- Cms (μm/N): 348.261
- Vas (l): 8.189
- Fs (Hz): 85
- Qes: 1.398
- Qms: 3.618
- Qts: 1.008
- Crossover Point: 5.8 kHz

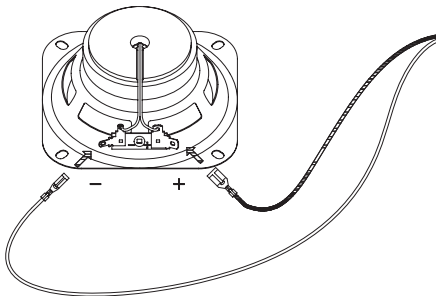
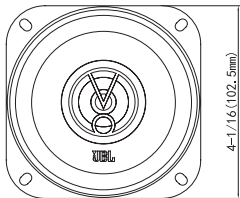
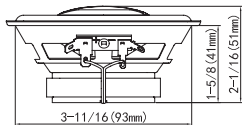
Stage2 424

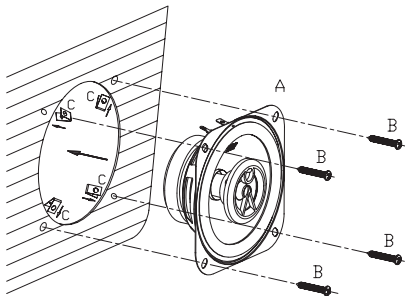



<p>A</p>  <p>2x</p>	<p>B</p>  <p>8x</p>	<p>C</p>  <p>8x</p>
--	--	--

規格

- 類型：4" (100mm) 雙向汽車喇叭
- 功率容量：25Wrms, 150W 峰值
- 靈敏度 (2.83 伏特) : 88dB
- 頻率響應：75Hz – 20kHz
- 額定阻抗：4 ohms



Thiele-Small 參數

- BL (Tm): 2.965
- DCR (ohm): 3.2
- Mms (g): 4.629
- Sd (cm²): 55.389
- Cms (μm/N): 409.235
- Vas (l): 1.785
- Fs (Hz): 115
- Qes: 1.224
- Qms: 4.583
- Qts: 0.966
- Crossover Point: 6.6 kHz

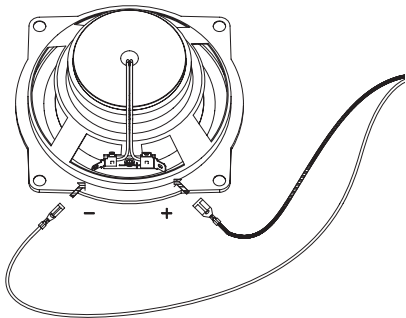
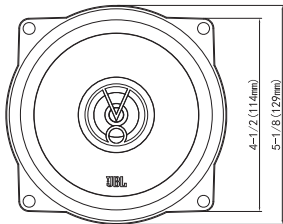
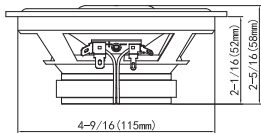
Stage2 524

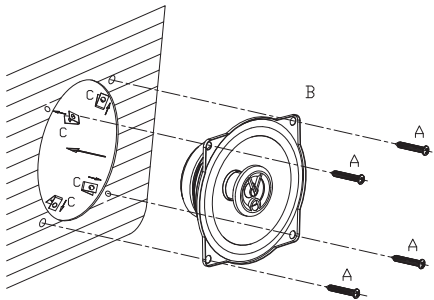



<p>A</p>  <p>8x</p>	<p>B</p>  <p>2x</p>	<p>C</p>  <p>8x</p>
--	--	--

規格

- 類型：5-1/4” (130mm) 雙向汽車喇叭
- 功率容量：35Wrms, 210W 峰值
- 靈敏度 (2.83 伏特) : 90dB
- 頻率響應：75Hz – 20kHz
- 額定阻抗：4 ohms

Thiele-Small 參數

- BL (Tm): 3.11
- DCR (ohm): 3.2
- Mms (g): 5.269
- Sd (cm²): 81.71
- Cms (μm/N): 506.563
- Vas (l): 4.803
- Fs (Hz): 95
- Qes: 1.067
- Qms: 4.525
- Qts: 0.864
- Crossover Point: 5.8 kHz



HARMAN International Industries,
Incorporated
8500 Balboa Boulevard, Northridge,
CA 91329 USA

© 2019 HARMAN International

Industries, Incorporated. 保留一切權利。

JBL 是 HARMAN International Industries, Incorporated 在美國與/或其他國家的註冊商標。

功能、技術規格和外觀如有變更,恕不另行通知。